

# MS500 系列

# MASSUSE SWITCH

## 規格

接觸材料：3A 120VAC/28 VDC.

電氣壽命：30,000 循環（滿負載）

初始接觸電阻：20MΩ（2.4VDC.100mA）

（適用於銀合金或鍍金觸點材料）

絕緣電阻：1,000MΩmin.

介質耐壓：1,000V RMS

工作溫度：-30°C ~ 85°C.

## 材料

外框-己二烯酞酸脂(DAP)

搖杆 - 尼龍

襯套 - 黃銅, 鍍鎳

墊圈 - 不銹鋼

終端觸點 銀合金, 鍍銀

線端 黃銅, 鍍銀

中心觸點和終端觸點 - 黃銅, 鍍銀



產品 編號	切換位置		
DS-41	ON	NONE	ON
DS-42	ON	OFF	ON
DS-43	ON	NONE	(ON)
Term.	2-3	OPEN	2-1
Comm..			

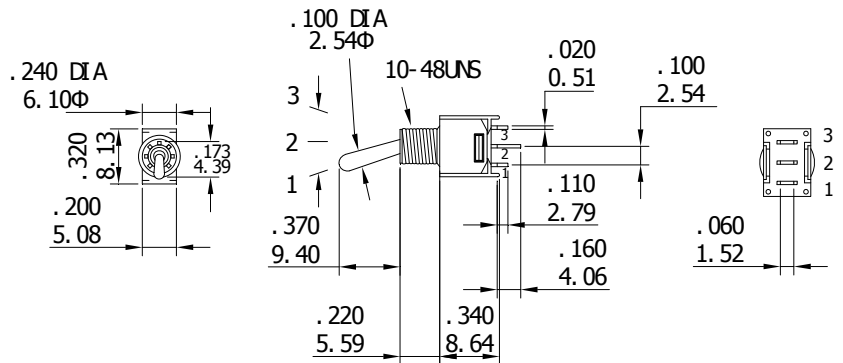

## SPDT

## Schematic

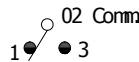

產品 編號	切換位置		
DS-51	ON	NONE	ON
DS-52	ON	OFF	ON
DS-53	ON	NONE	(ON)
Term.	2-3	OPEN	2-1
Comm..	5-6		5-4

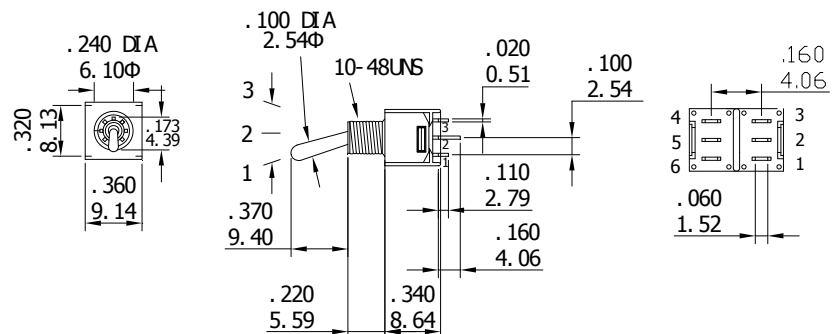

## DPDT

## Schematic

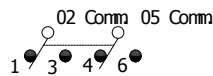

產品 編號	切換位置		
DS-61	ON	NONE	ON
DS-62	ON	OFF	ON
DS-63	ON	NONE	(ON)
Term.	2-3	OPEN	2-1
Comm..			

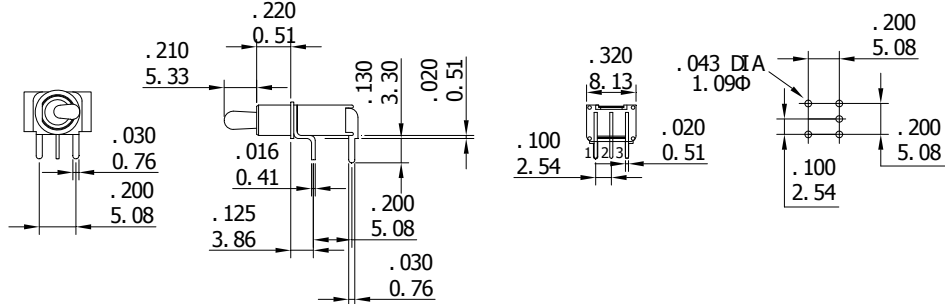

## SPDT

## Schematic

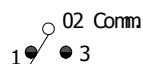

# MS500 系列

# MASSUSE SWITCH



**DPDT**

產品 編號	切換位置		
	DS-71	ON	NONE
DS-72	ON	OFF	ON
DS-73	ON	NONE	(ON)
Term.	2-3	OPEN	2-1
Comm..	5-6		5-4

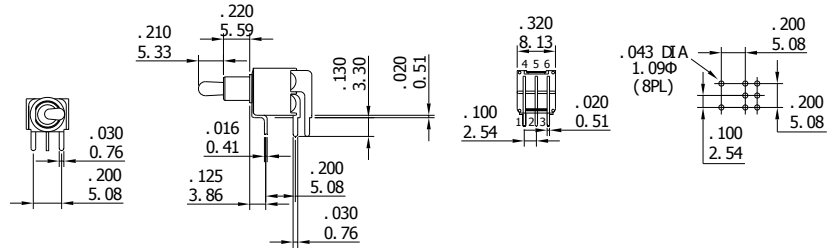
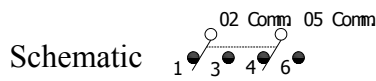

**SPDT**

產品 編號	切換位置		
	DS-81	ON	NONE
DS-82	ON	OFF	ON
DS-83	ON	NONE	(ON)
Term.	2-3	OPEN	2-1
Comm..			

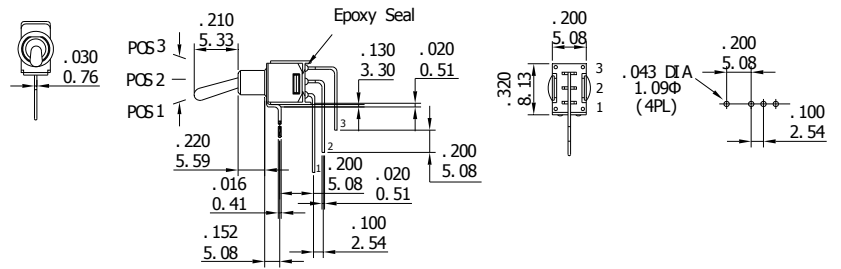
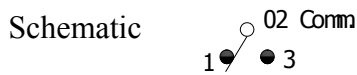

**DPDT**

產品 編號	切換位置		
	DS-91	ON	NONE
DS-92	ON	OFF	ON
DS-93	ON	NONE	(ON)
Term.	2-3	OPEN	2-1
Comm..	5-6		5-4

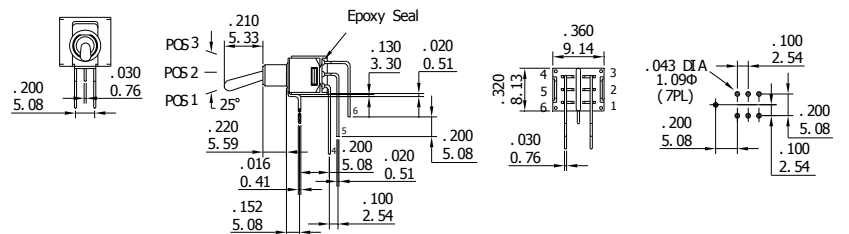
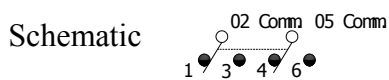

## VERTICAL SUPPORT BRACKET OPTIONS

### DS-10



### SPDT

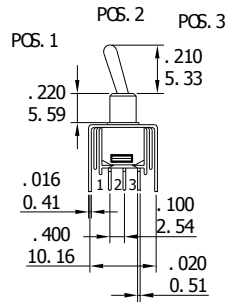

### P.C. MOUNTING

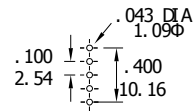

### DS-20



### DPDT

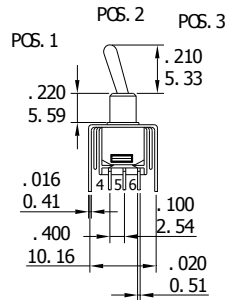

### P.C. MOUNTING

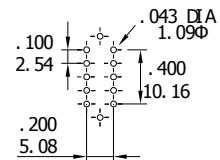

## ACTUATOR OPTIONS

### T1 SID

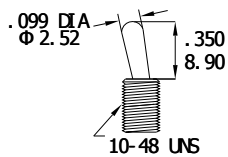

### T2

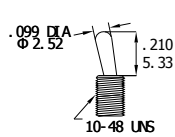

### T3

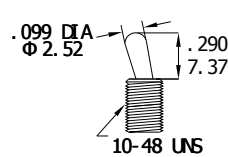

### T4

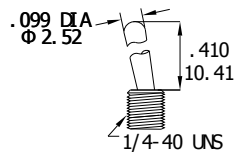

### T5

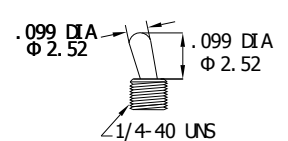

## BUSHING OPTIONS

### B1 THD

### B2 NON-THD

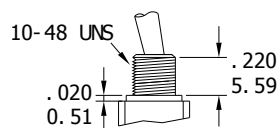

### B3 THD

### B4 NON-THD

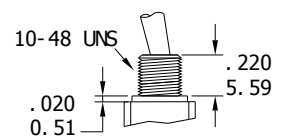
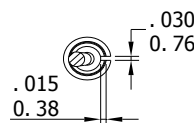

B5 THD  
B6 NON-THD

B7 THD  
B8 NON-THD

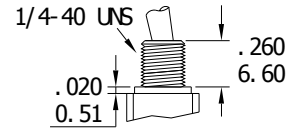
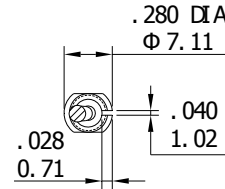
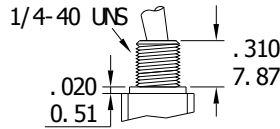
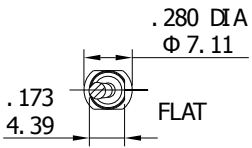

## TERMINATION OPTIONS

A1

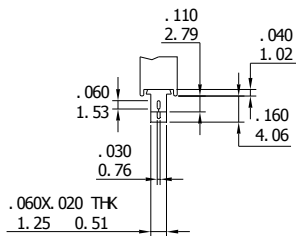

A2

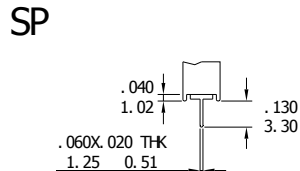

A3

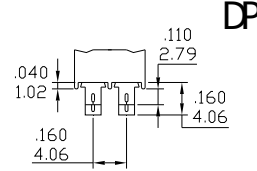

A4

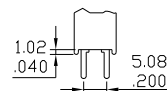

## 觸點材料

Q

終端觸點: 銀合金, 鍍銀.

中心觸點和終端觸點 - 黃銅, 銀鎳合金

負載: 3 A 125/ 28 VDC; 1 A 250 VAC.

R

觸點&終端: 黃銅, 鍍金

負載: 0.4 VA max. @ 20 VAC 或 DC max.