

特點

- 2a2b,3a1b,4a 的觸點形式
- 磁保持和非磁保持可供選擇
- 外形尺寸：36.8 × 22.6 × 14.6 mm (L x W x H)

觸點參數

觸點形式	2a2b ; 3a1b;4a
接觸電阻 (初始)	Max. 50mΩ (在 1A / 6VDC 下)
負載(阻性)	6A 250VAC
負載 (感性)	220VDC T=5ms 50W 22VDC T=5ms 6A 不斷弧 10000 次 220VDC COS φ =0.4 250VAC
觸點過負載能力	可長期接通 220VDC 6A;可 接通、斷開 220VDC,感性負 載 T=5ms 100W 100 次
最大切換電壓	220VDC/250VAC
最大切換電流	6A
觸點材料	Silver Alloy

性能參數

絕緣電阻	1000MΩ 在 500VDC 下
介質耐壓	1500VAC, 同組開觸點間 2500VAC, 不同組觸點間 2500VAC,線圈與觸點間 2000VAC,雙線圈間
最小動作脈寬 (磁保持型)	五倍動作時間
動作時間	10 ms (額定電壓)
釋放時間	10 ms (額定電壓)
振動	10-55Hz 雙振幅為 1.5mm
衝擊	加速度達 294m/s ²
相對濕度	40% ~ 95%RH
環境溫度	- 40°C ~ + 70°C
壽命	
- 電氣	1 x 10 ⁵ 次 min.
- 機械	1 x 10 ⁷ 次 min.

線圈參數 - 1. 單線圈單穩態

額定電壓 (VDC)	動作電壓 VDC (Max.)	釋放電壓 VDC (Min.)	額定電流 (mA±10%)	線圈電阻 (Ω±10%)	線圈功率 (mW)	最大電壓 (VDC)
1.5	1.125	0.15	333	4.5	500	1.8
3	2.25	0.3	167	18	500	3.6
5	3.75	0.5	100	50	500	6
12	9	1.2	42	288	500	14.4
24	18	2.4	21	1152	500	28.8
48	36	4.8	10.5	4608	500	57.6
55	41.25	5.5	9	6050	500	66
110	82.5	11	5	24200	500	132

2. 雙線圈單穩態

額定電壓 (VDC)	動作電壓 VDC (Max.)	釋放電壓 VDC (Min.)	額定電流 (mA±10%)	線圈電阻 (Ω±10%)	線圈功率 (mW)	最大電壓 (VDC)
1.5	1.125	0.15	333	4.5	500	1.8
3	2.25	0.3	167	18	500	3.6
5	3.75	0.5	100	50	500	6
12	9	1.2	42	288	500	14.4
24	18	2.4	21	1152	500	28.8
48	36	4.8	10.5	4608	500	57.6
55	41.25	5.5	9	6050	500	66
110	82.5	11	5	24200	500	132

3. 雙線圈雙穩態

額定電壓 (VDC)	動作電壓 VDC (Max.)	釋放電壓 VDC (Min.)	額定電流 (mA±10%)	線圈電阻 (Ω±10%)	線圈功率 (mW)	最大電壓 (VDC)
1.5	1.125	0.15	333	4.5	500	1.8
3	2.25	0.3	167	18	500	3.6
5	3.75	0.5	100	50	500	6
12	9	1.2	42	288	500	14.4
24	18	2.4	21	1152	500	28.8
48	36	4.8	10.5	4608	500	57.6
55	41.25	5.5	9	6050	500	66
110	82.5	11	5	24200	500	132

訂貨標記示例

ME-8FF - L1 - 03 2a2b

型號	線圈類型	線圈電壓	觸點形式
ME-8FF	Nil:單線圈單穩態 2:雙線圈單穩態 L1:單線圈雙穩態 L2:雙線圈雙穩態	1.5, 3, 5, 12, 24, 48, 55and 110VDC	2a2b: 2A2B 3a1b: 3A3B 4a:4A 4b:4B

外形尺寸圖、接線圖、安裝孔位圖(單位：mm)

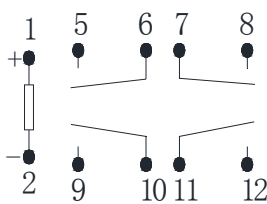
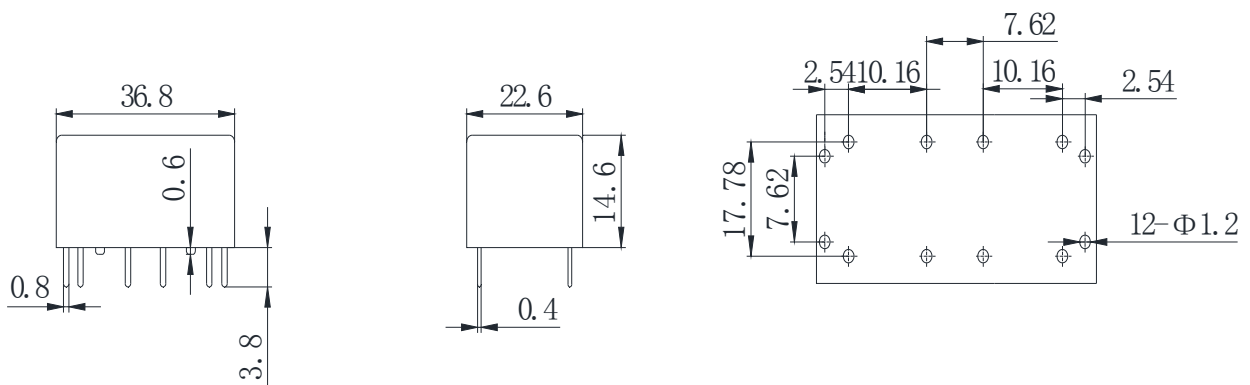

1 coil non-latch:4a
1 coil latch:4a

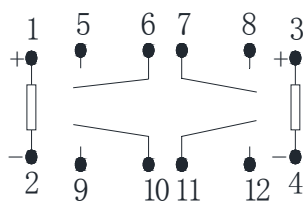

2 coil non-latch:4a
2 coil latch:4a

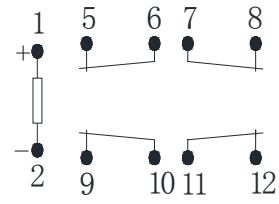

1 coil non-latch:4b
1 coil latch:4b

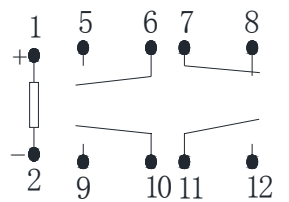

1 coil non-latch:3a1b
1 coil latch:3a1b

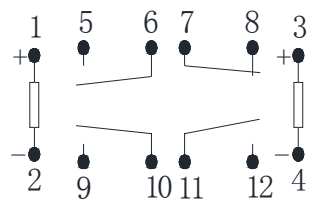

2 coil non-latch:3a1b
2 coil latch:3a1b

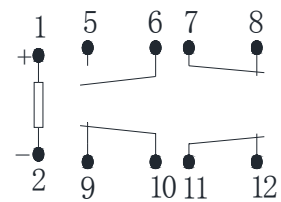

1 coil non-latch:1a3b
1 coil latch:1a3b

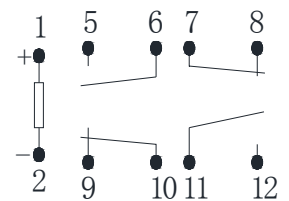

1 coil non-latch:2a2b
1 coil latch:2a2b

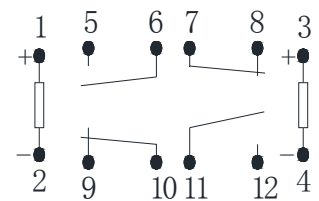

2 coil non-latch:2a2b
2 coil latch:2a2b

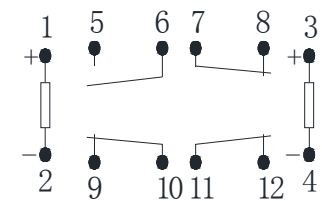

2 coil non-latch:1a3b
2 coil latch:1a3b

聲明：本產品規格書僅供客戶使用時參考，若有更改，恕不另行通知。